

Weather Monitoring Unit - MCRP 054

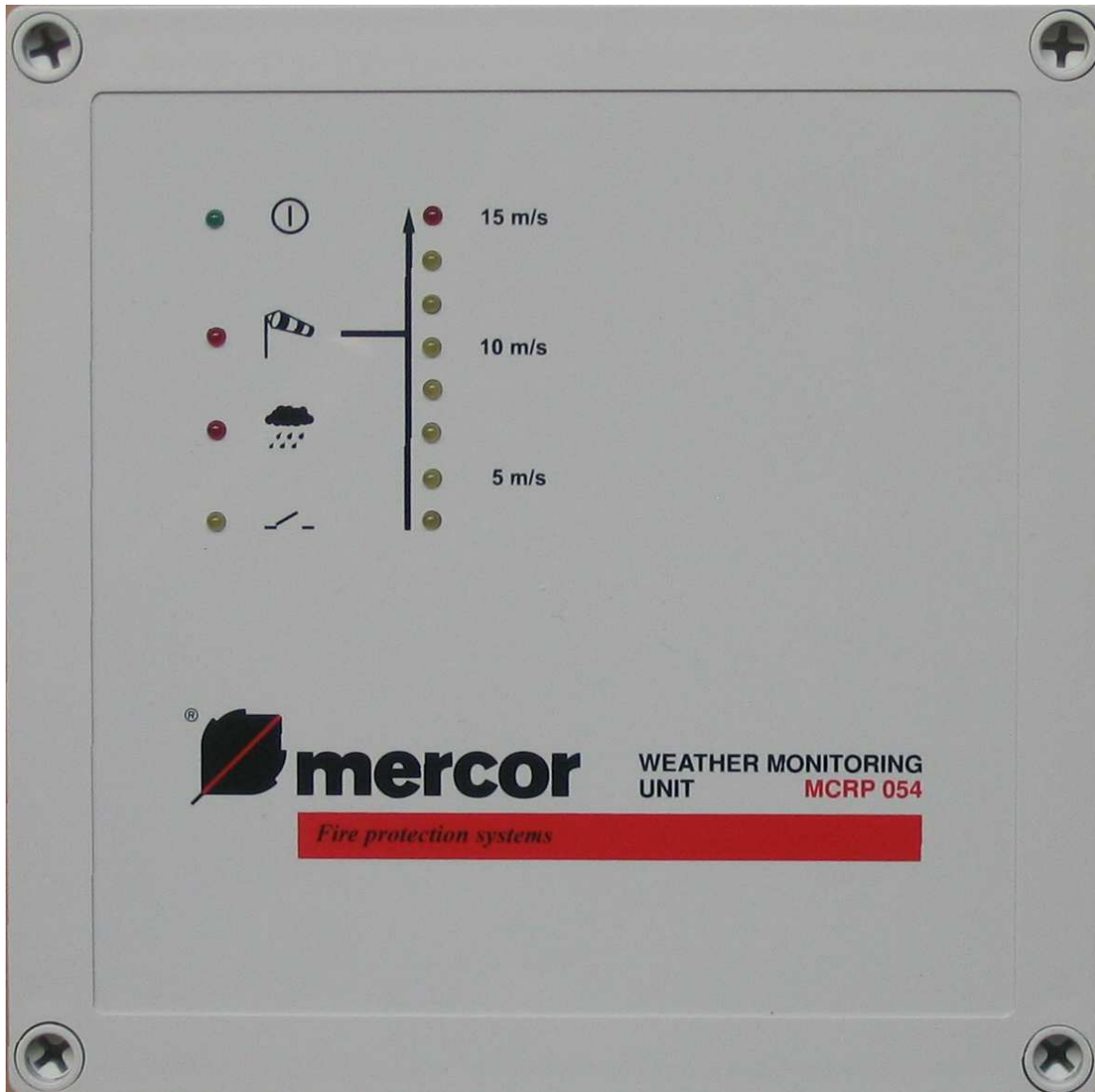

Technical and Operating Documentation User Instruction Manual

MERCOR SA
Ul. Grzegorza z Sanoka 2
80-408 Gdańsk
tel. (+48) 058 341 42 45, fax (+48) 058 341 39 85

Table of Contents

1. USER INFORMATION	2
2. INTRUCTION	3
3. ABOUT THE MCRP054 WEATHER MONITORING UNIT	4
3. OPERATION	6
4. WARRANTY TERMS AND CONDITIONS.....	7
5. SERVICE.....	7
6. ASSEMBLY AND START UP	8
7. TECHNICAL SPECIFICATIONS.....	8

1. User information

Thank you for selecting the MCR 9705 weather monitoring unit. Please, read these instructions carefully and follow the guidelines. This will ensure smooth and reliable operation of the device.

MERCOR SA reserves the right to modify the product or the documentation without notice.

We wish to ensure your full satisfaction with our products and we will be glad to provide professional service and assistance to you, if necessary.

MERCOR SA

Please keep this Instruction Manual, so that the information is always available when required.

2. Introduction

1. The MCRP 054 weather monitoring unit is used to control the operation of actuators in the MCR-PROLIGHT and MCR PROLIGHT+ vents or in ventilation windows which should be closed in wind or rain.
2. To the weather monitoring unit smoke exhaust control units, ventilation control units or electromechanical actuators powered by 230 V or 24 V voltage.
3. The closing signal is generated on the basis of readings from a WM1 wind sensor and the RS1/RS2 rain sensor.
4. Output: the device has four switches which are activated in the event of wind/rain or when mains voltage is lost. The switch remains activated for a pre-set time after the rain/wind has ceased.
5. The value of rain intensity which activates the alarm can be adjusted by the user (drizzle – heavy rain).
6. The value of wind force which activates the alarm can be adjusted by the user - from a gentle breeze (about 5 m/s) to a gale (about 15 m/s).
7. Additional input for a vent position sensor (the circuit is closed when the vents are open) makes it possible to optically control the vent status.
8. The device is equipped with the optical signals to indicate the following status:
 - 230V~ power supply green LED
 - “Wind” alarm red LED
 - “Rain” alarm red LED
 - “Vent open” signal amber LED
9. The device is equipped with the wind speed indicator – a line indicator consisting of 7 amber LEDs and one red LED (for wind speeds over 15 m/s).
10. Wall-mounted plastic housing, H x W X D: 180 x 180 x 75 mm; protection class IP54, colour: light grey (~RAL 7035), leads outlets either on top or at the rear of the housing.
11. It is possible to connect the weather monitoring unit to a remote control module which contains optical indicators and potentiometers for setting the desired sensitivity of the wind/rain sensors.

3. About the MCRP054 weather monitoring unit

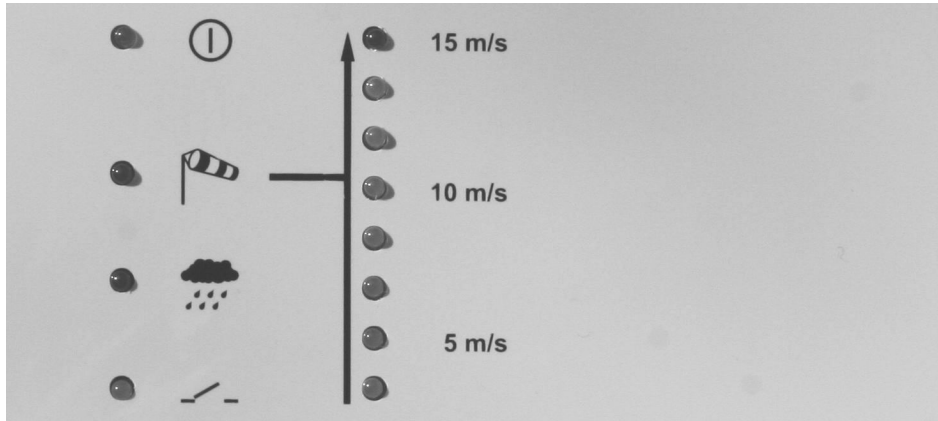





Fig. 1 Monitoring unit's front panel.

On the front panel, there are **LEDs** which indicate the status of the control center:

#	Description	Color	Function
1	POWER SUPPLY 	green	indicates presence of power supply
2	WIND 	red	wind alarm
3	RAIN 	red	rain alarm
4	VENT OPEN 	amber	indicates that smoke vents (windows) are open
5	WIND SPEED	7 x amber 1 x red	wind speed – LED line indicator; scale from about 0 m/s to about 15 m/s

The interior of the weather monitoring unit is shown in Fig. 2.

At the bottom left section of the unit's PCB, there are two potentiometers (1,2).

Potentiometer 1 is used to set the sensitivity of the rain sensor: from a drizzle (far left) to a heavy rain (far right).

Potentiometer 2 is used to set the sensitivity of the wind sensor: from 5 m/s (far left) to 15 m/s (far right).

Above the potentiometers there are two jumpers: **H2** (3) and **H3** (4). They are used to switch the weather monitoring unit into the remote control mode:

 remote control mode

 local control mode (factory settings)

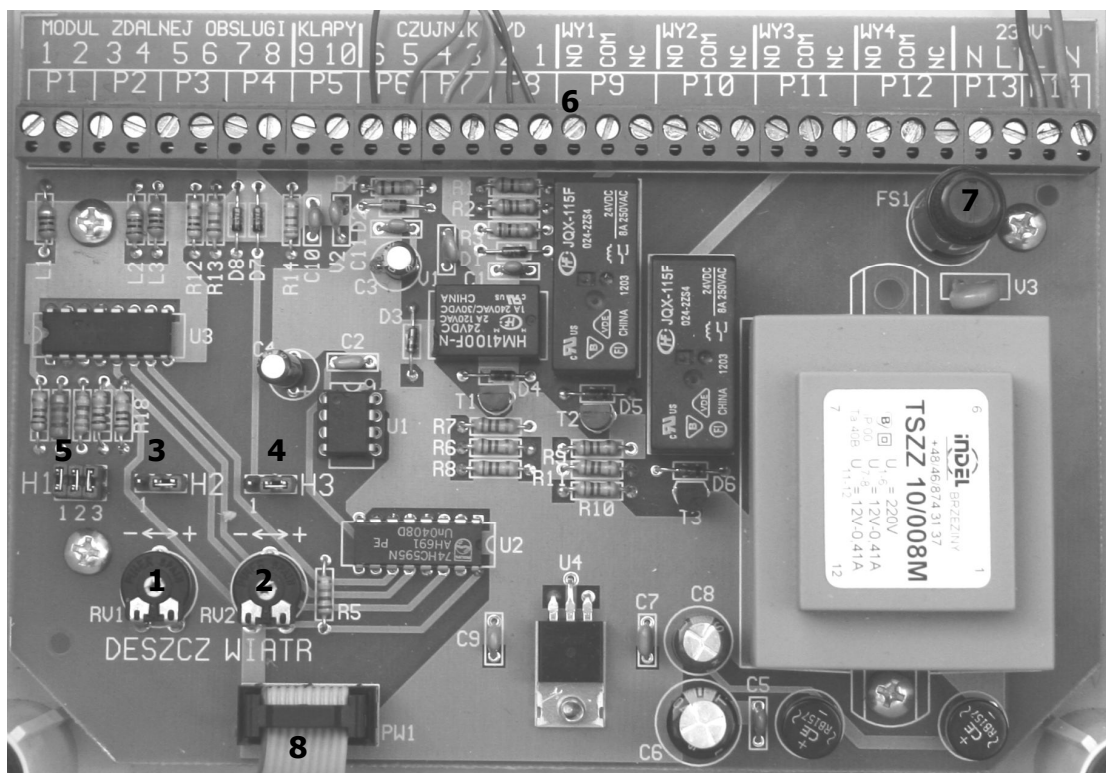





Fig. 2. View of the unit's interior.

At the left edge of the board, there's a set of time coding jumpers **H1** (5) used to code the desired time during which the alarm will remain on after the cause of the alarm (i.e. wind or rain) has ceased:

Minimum alarm duration

-  4 minutes
-  6 minutes
-  8 minutes
-  10 minutes

Along the top edge of the module's PCB there are terminal strips (6) which are used to connect the elements of the system:

Description	Function
P1 ... P4	input for remote control module
P5	input for vent opening sensor
P6 ... P7	input for wind/rain sensor
P9	output 1 from the unit (switch)
P10	output 2 from the unit (switch)
P11	output 3 from the unit (switch)
P12	output 4 from the unit (switch)
P13	auxiliary output 230 V, 50 Hz, max 5 A
P14	power supply input 230 V, 50 Hz

On the board there is an circuit breaker FS1 (7) - 125 mA quick.

PW1 contact (8) is used to connect the indicator board mounted in the unit's cover.

3. Operation

3.1. Normal operation

Description of optical LED indicators on the front panel (fig. 1):

POWER SUPPLY	WIND	RAIN	VENT OPEN	UNIT STATUS
+			+	VENT OPEN
+	+			ALARM - WIND
+		+		ALARM - RAIN
+	-	-		NO ALARM
-	-	-		NO POWER SUPPLY

+ ANY STATUS
 ON
 - OFF

MCRP 054 is a maintenance-free device. It requires uninterrupted 230 V mains power supply. Should there be power outage caused by mains failure, the unit will generate the vent closing signal on output terminals.

3.2. Alarm

The wind/rain sensor will automatically close smoke vents (or prevent the vents from being opened by using the ventilation pushbutton) if the wind or atmospheric precipitation is too strong/heavy.

When the weather monitoring unit is in the alarm mode, the red LED will light up on its door, and the alarm signal will be generated on output terminals.

In the alarm mode, the NO contact is open and NC contact is closed with the COM contact.

The alarm will switch off automatically when the factor which released the alarm ceases, after a period of time set by adjusting the H1 (5) jumpers.

4. Warranty terms and conditions.

1. MERCOR SA gives twelve-month warranty for the purchased equipment, unless the "delivery contract" or "delivery and assembly contract" stipulates otherwise.
2. If during the warranty period any fault resulting from a latent defect in equipment occurs, MERCOR SA undertakes to eliminate the fault within 21 days from the notification date. In the case of a fault resulting from incorrect operation of equipment or from other reasons not being on the part of MERCOR SA, the buyer shall bear the costs of eliminating the fault.
3. MERCOR SA reserves the right to extend the repair time in the case of complicated repairs or repairs which require a purchase of non-standard subassemblies [elements] or spare parts.
4. In accordance with generally accepted practice, the warranty does not cover:
 - equipment damage and failure caused by incorrect operation, or lack of maintenance, or lack of periodical inspections.
 - equipment damage due to reasons other than those being on the part of MERCOR SA and, in particular, events of a fortuitous nature in the form of torrential rainstorm, flood, hurricane, inundation, lightning, overvoltage in electrical system, explosion, hail, aircraft fall, fire, avalanche, landslide and consequential damage resulting from the above mentioned reasons. A torrential rainstorm shall mean rainfall of intensity factor not lower than 4. The hurricane shall mean a wind of a speed of at least 17.5 m/s.
 - damage arising from omission of the duty to report promptly any noticed defect.
 - deterioration in the quality of coating caused by a process of natural decay (fading out, oxidisation).
 - defects caused by application of abrasive or aggressive cleaning agents.
 - parts which normally wear out during operation (for example gaskets), unless a manufacturing defect did occur in them.
5. Any defect covered by the warranty should be reported to MERCOR SA immediately.
6. The buyer is obligated to operate and maintain the purchased equipment correctly, to carry out periodical service inspections (at least twice a year) and to enter each service inspection in the "construction facility book"..
7. **The warranty expires with immediate effect:**
 1. **if the buyer or user make structural modifications on their own without prior agreement with MERCOR SA;**
 2. **if the maintenance or periodical service inspection was not performed within specified time limits or was performed by a service unit not authorized by MERCOR SA, or the equipment was operated incorrectly;**
 3. in the case of any interference by unauthorized persons, excluding the activities within the scope of normal operation of equipment.

As regards matters not regulated by these "Warranty terms and conditions", relevant regulations in the Civil Code, and in particular Art. 577-581 shall apply.

5. Service.

1. Periodical service inspections of the equipment should be carried out during the whole service life of the equipment.
 - every 6 months if the equipment represents a component of a smoke exhaust system
 - every 12 months if the equipment represents a stand-alone control system for daily ventilation, not connected to a smoke exhaust system
2. The service inspections should be carried out by a firm properly authorized by Mercor SA.
3. For service-related issues, please contact the Service Department, phone no. +48 58 341 4245 ext. 127 or fax: +48 58 341 3985, 8 am – 4 pm (Monday-Friday).

6. Assembly and start up

Connection diagrams are show on pages 9 ... 12.

1. **Wind/rain sensor** - 4 leads (YTKSY or YDY) from P6 ... P8 terminals.
2. **Vent opening sensor** - 2 leads from P5 terminals. The contact is closed when the vents are open (optional feature).
3. **Remote control module** - 8 leads from P1... P4 terminals (optional feature).
4. **Power supply 230 V, 50 Hz** should be connected to the P14 terminal strip. The power supply line for the unit should be protected by means of a properly marked overload circuit breaker in the switching station. The recommended circuit breaker: max. 6.3 A.
5. **Start-up.** Before switching on the power supply, check if the leads are connected properly.

Note: the leads should be placed and connected in accordance with relevant standards and basic rules for wiring. In order to connect the unit you should use leads which satisfy the requirements of current regulations.

7. Technical specifications.

Item	Value
Power supply voltage	230 V ^{+10%} _{-15%} 50 Hz
Rated power	10 VA
Load for relay outputs	max. 5 A, 230 V~
Number of control groups (number of output terminals)	4
Load on auxiliary output terminal (P13)	max. 5 A
Working temperature range	-5°C ÷ +50°C
Climatic grade in accordance with WBO/11/11/CNBOP/2002	I
Protection level for housing	IP 54
Dimensions (H x W x D)	300 x 300 x 150 mm
Compatible sensors	RS1-WM1 and RS2-WM1

7. Wiring diagrams

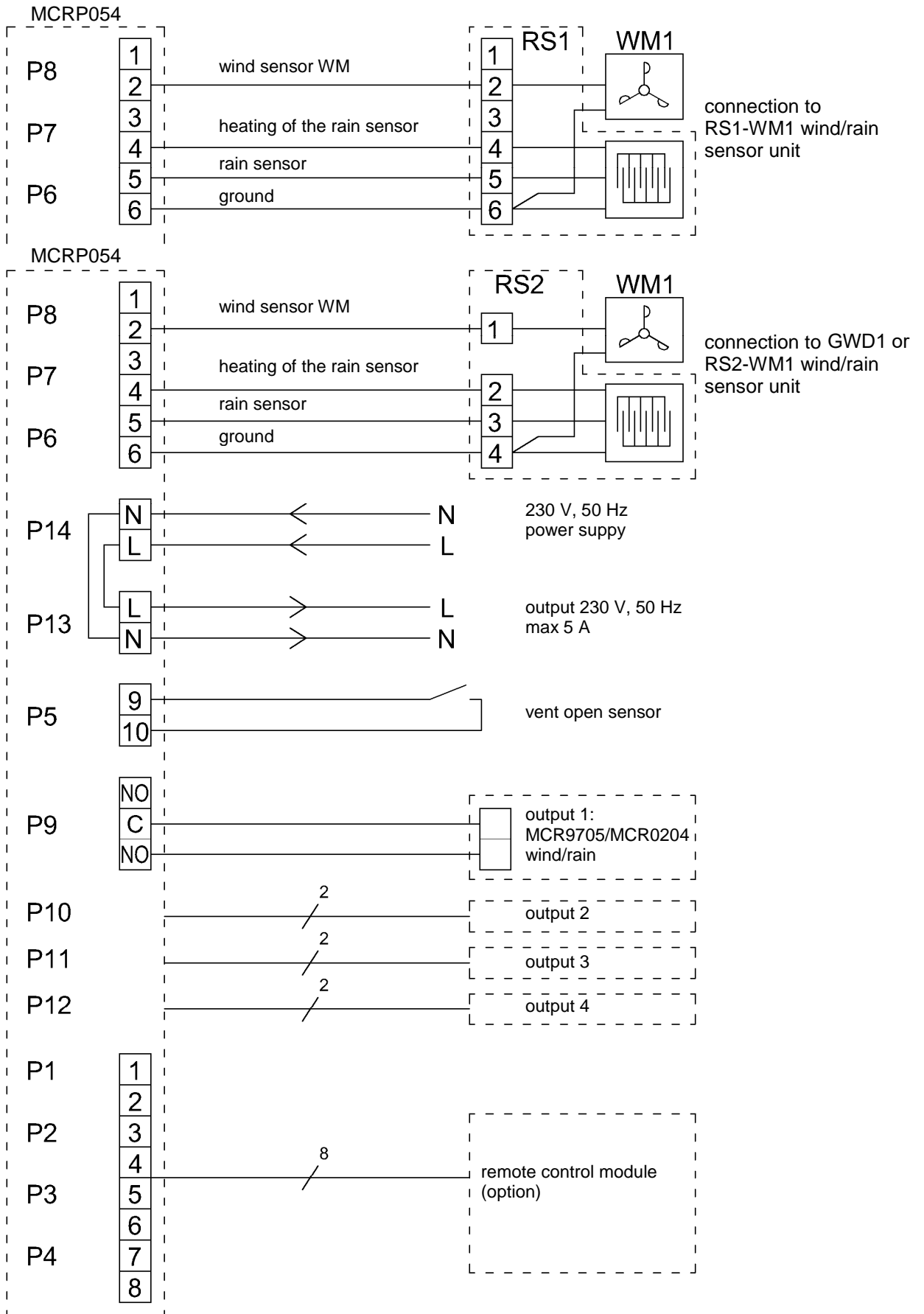

Drawing 1. Connection for the MCRP 054 weather monitoring unit with a RS2-WM1 sensor .

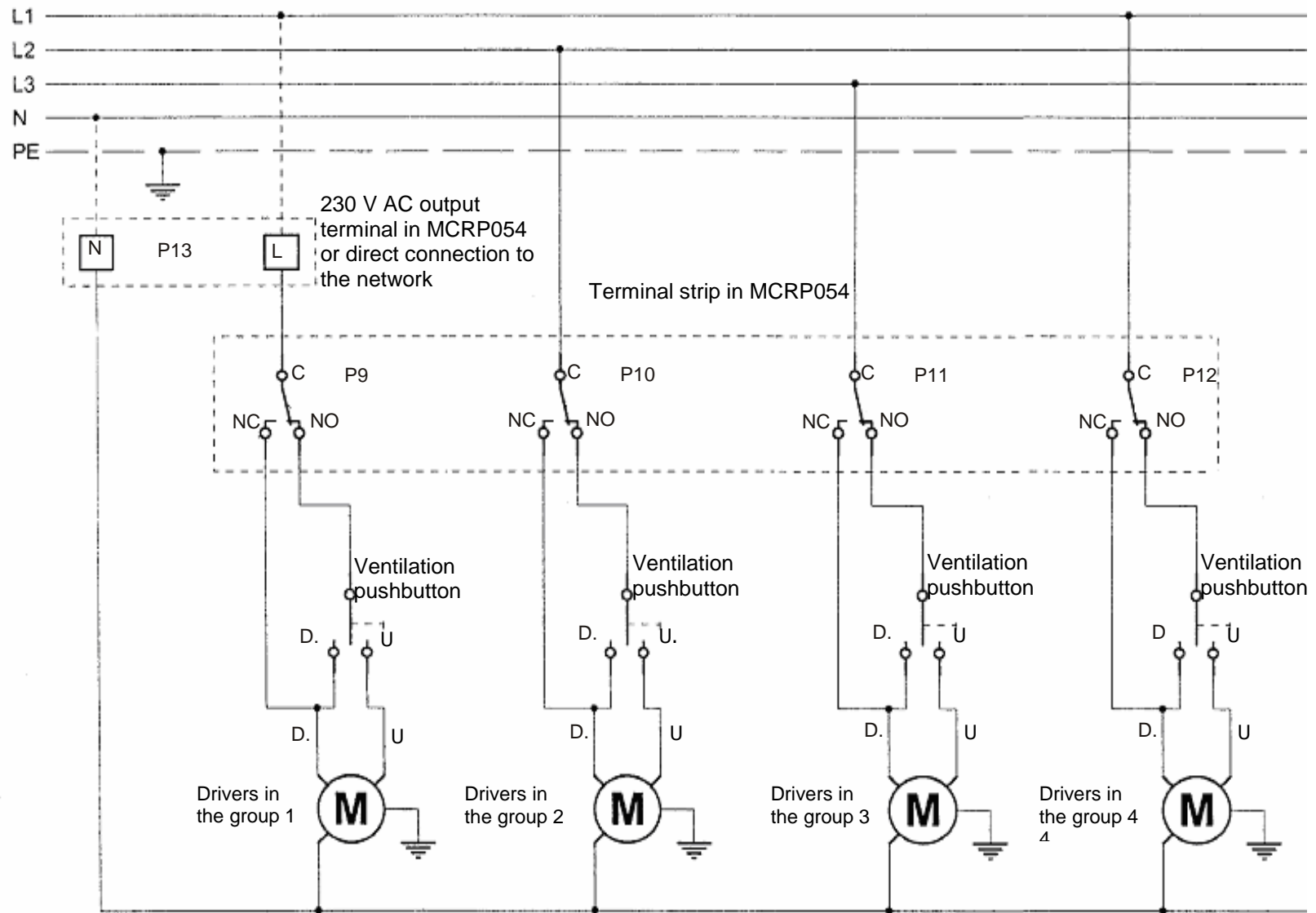

Drawing 2. Diagram for connection of 230 V~ ventilation actuators to the MCRP 054 weather monitoring unit.

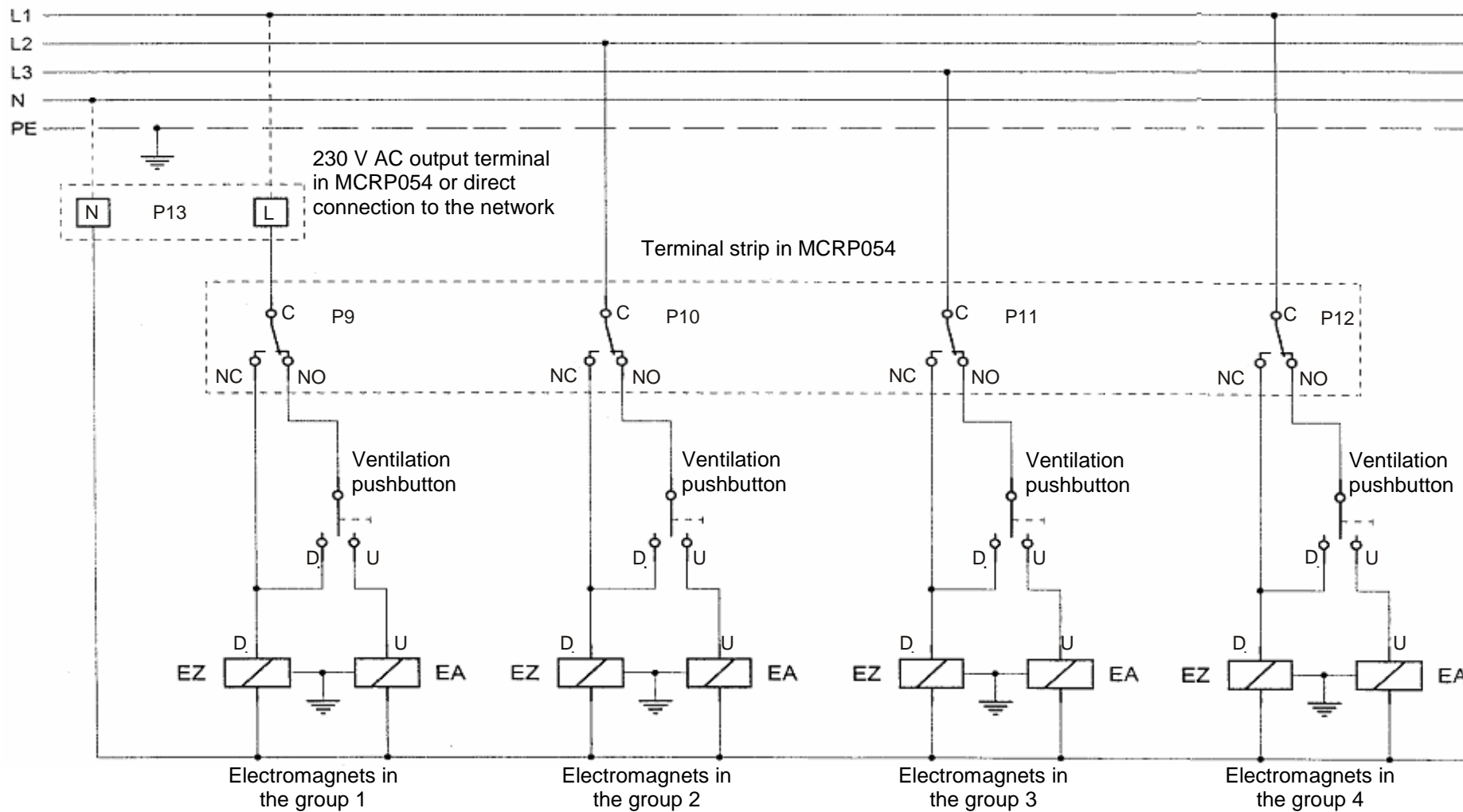

Drawing 3. Diagram for connection of pneumatic ventilation boxes (LUK) with the EA/EZ (230 V~) option to the MCRP 054 weather monitoring unit.

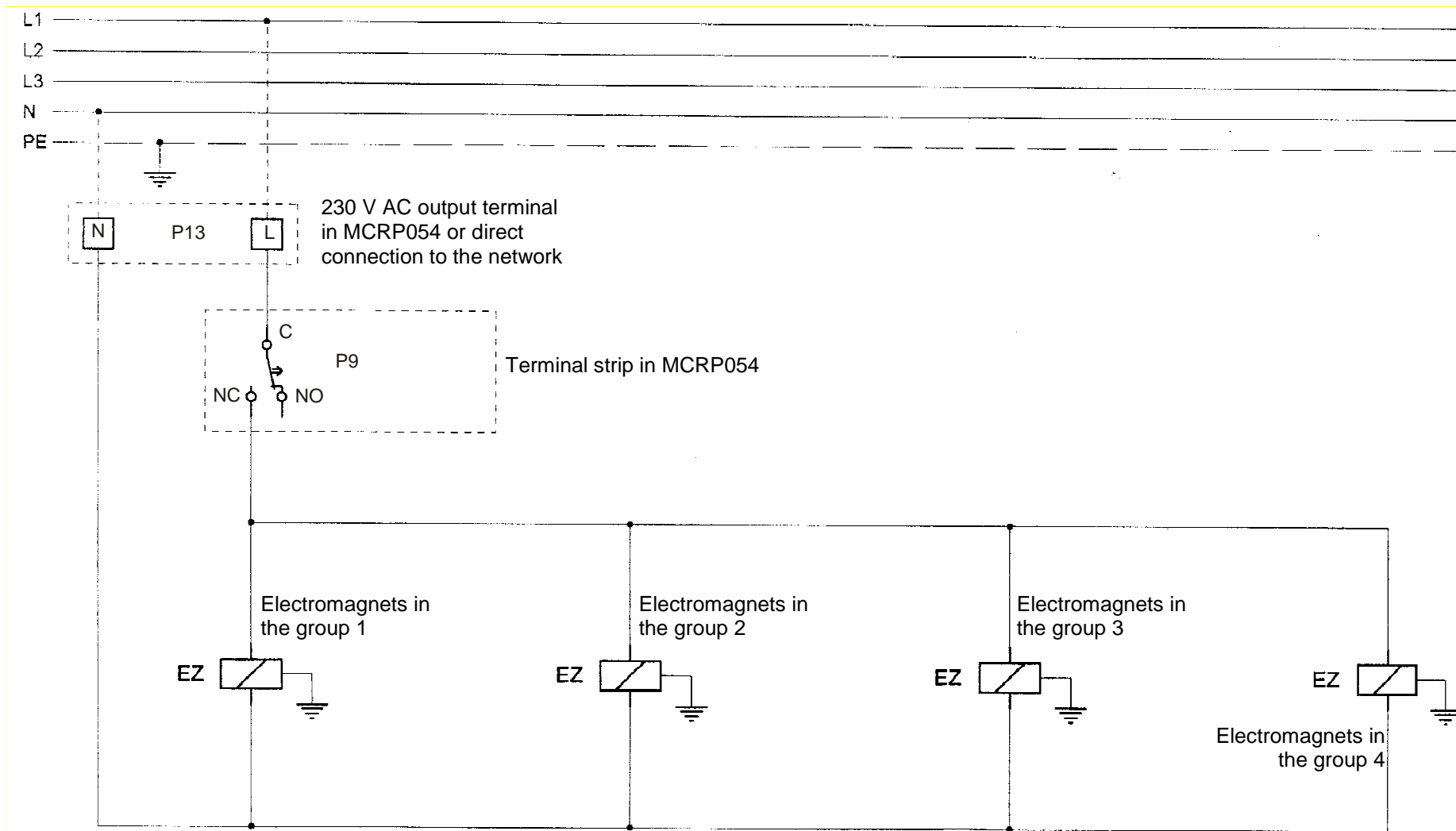

Drawing 4. Diagram for connection of pneumatic ventilation boxes (LUK) with the EZ (230 V~) option to the MCRP 054 weather monitoring unit.